 1=1.7m 2=0.75m 3=1.21m

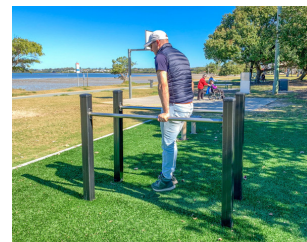

INSTALACIÓN

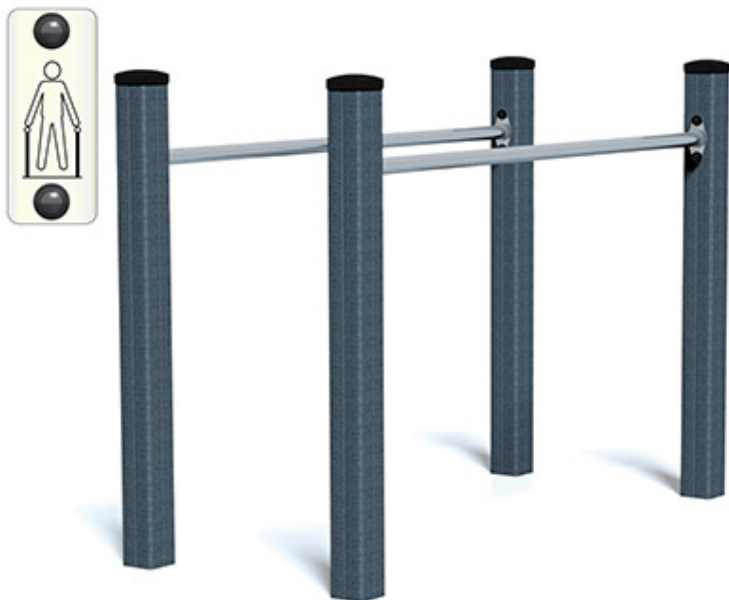

INFORMACIONES DIVERSAS

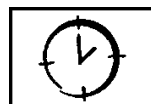

1 jugador

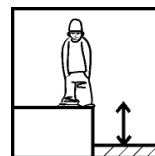

HCL= 1m

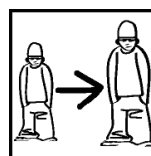

14+

CERTIFICACIONES

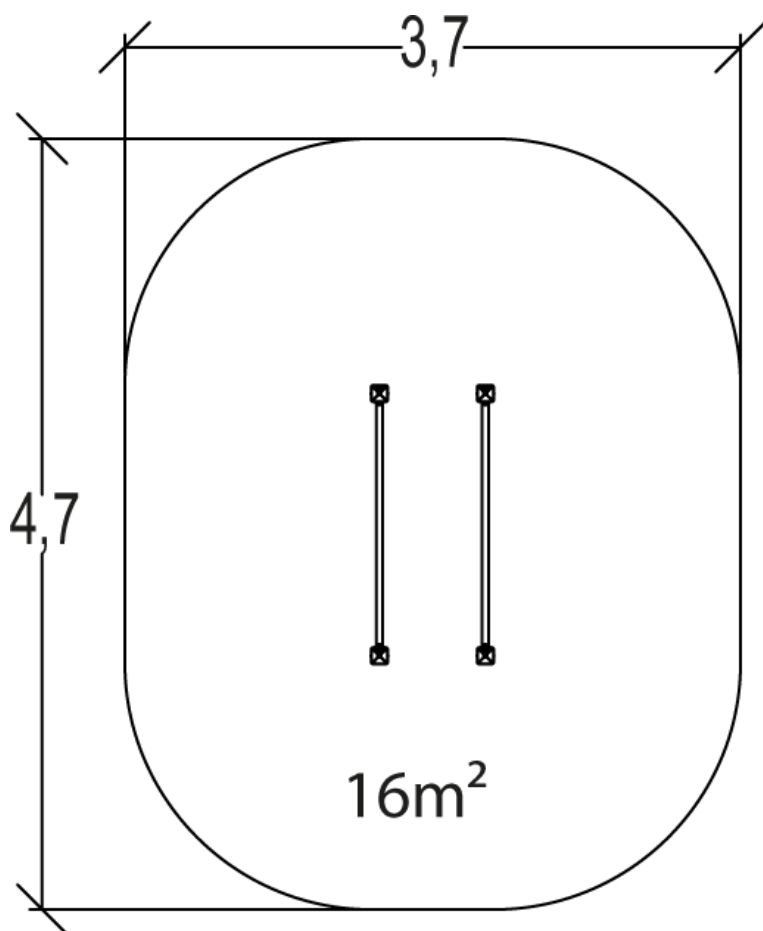
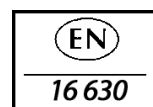

Peso del juego = 55 kg

Elemento más pesado = 12 kg