 1=1.69m 2=0.75m 3=0.8m

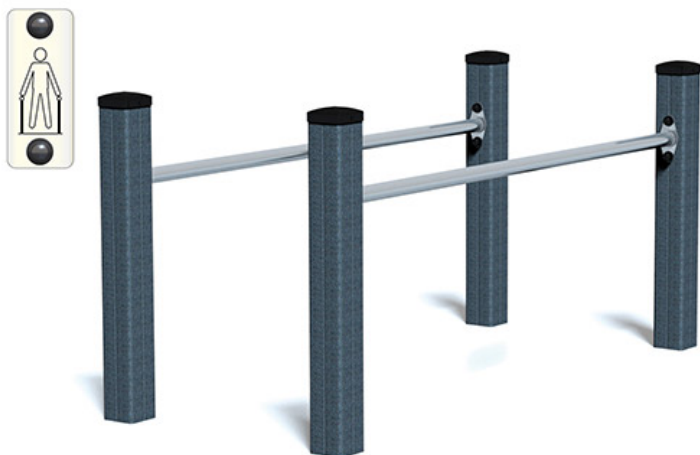

**INSTALACIÓN**

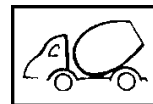

0.1m<sup>3</sup>



1

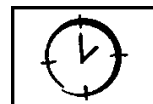

01h00

**INFORMACIONES DIVERSAS**



1 jugador

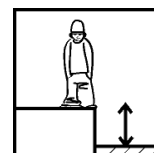

HCL= 0.6m

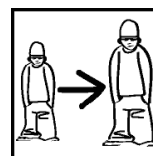

6-14 años

**CERTIFICACIONES**

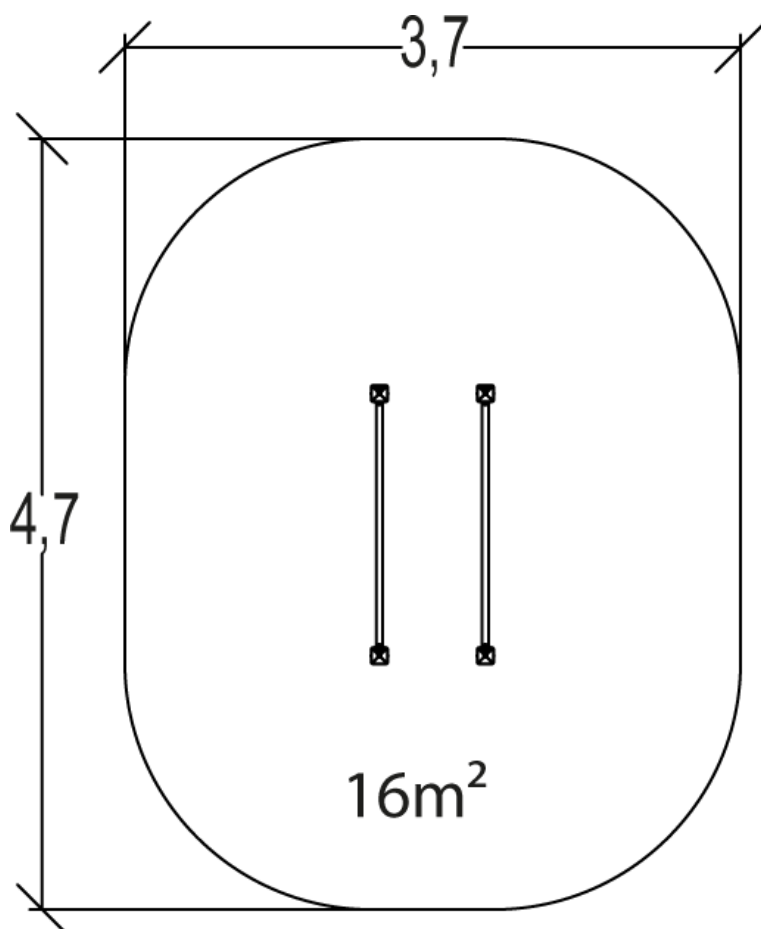
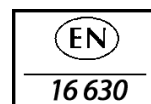

Peso del juego = 44 kg

Elemento más pesado = 9 kg