

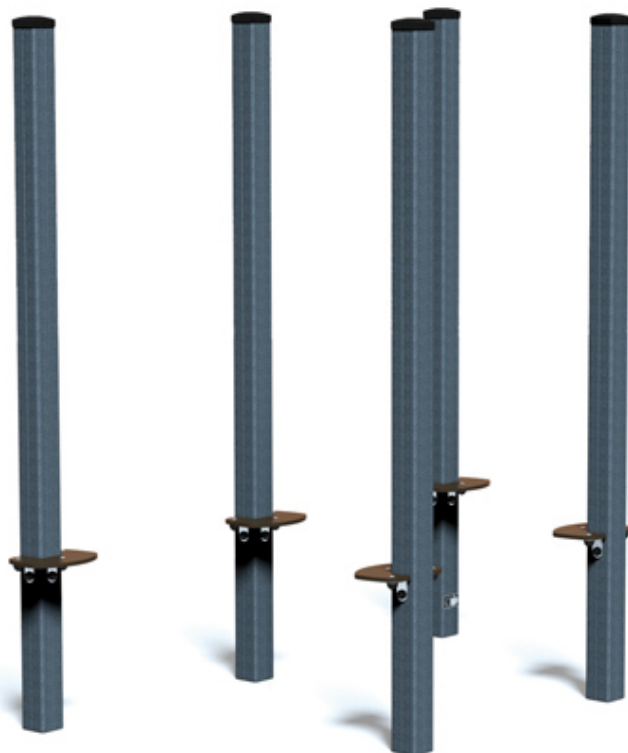

1=2.26m 2=1.19m 3=2.21m

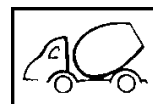

**INSTALACIÓN**



0.15m<sup>3</sup>



2

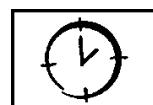

03h00

**INFORMACIONES DIVERSAS**



2 jugadores

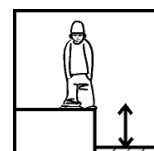

HCL= 0.55m

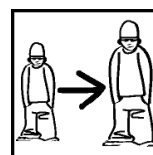

6+

**CERTIFICACIONES**

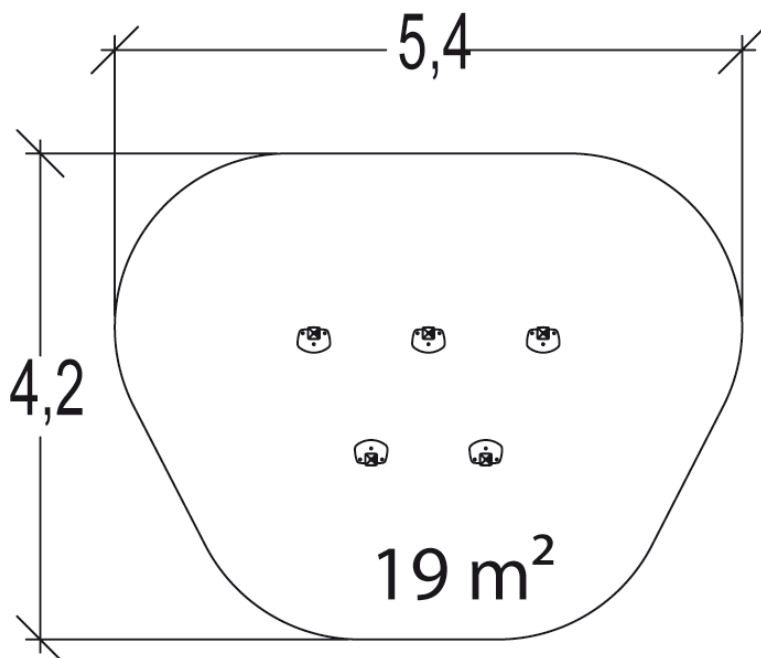
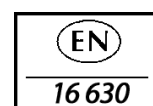

Peso del juego = 100 kg

Elemento más pesado = 18 kg