



1+



2



1,28m



1 = 3,34m
2 = 1,98m
3 = 2,6m



Discapacidad motriz
Discapacidad sensorial
Discapacidad mental

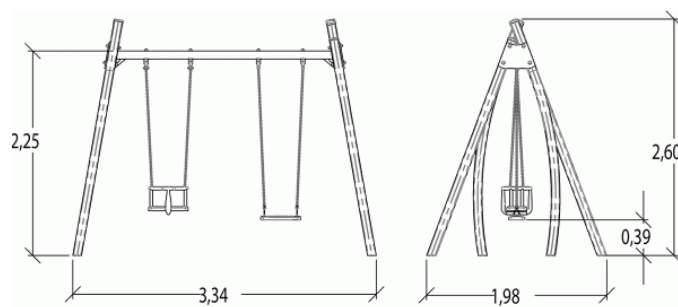

Funciones Lúdicas : 4

encontrarse



x1

descansar



x1

columpiarse



x2

Elementos constituyentes

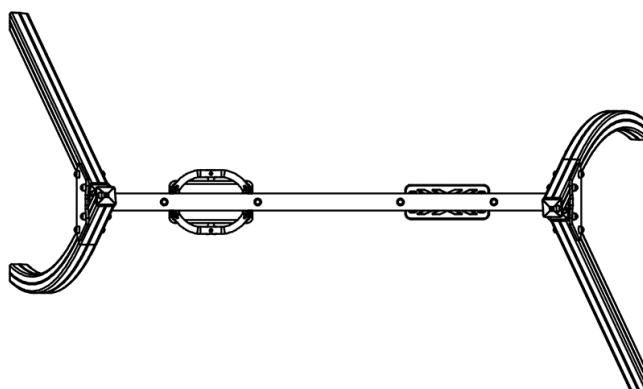

Instalación del equipamiento

Zona de impacto: Superficie de suelo mínima requerida

- Zona de impacto
- Espacio libre



Zone d'Impact Sol souple
Impact Area Wetpour
Area de Impacto
Fallraum bei synthetischem Fallschutz



Zone d'Impact Sol fluent
Impact Area Loose particle material
Arenero
Fallraum bei losem Bodenmaterial



1	1,2m	19,2m ²
2	1,2m	22,2m ²

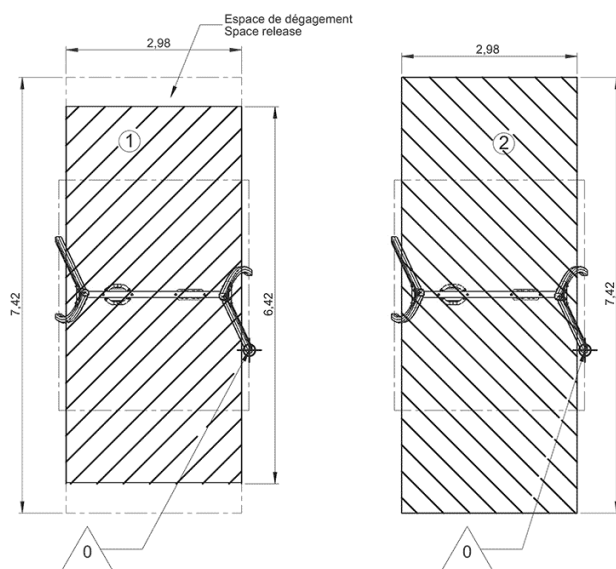

2

1h30

0.11m³

19.5m²

149kg

30kg

EN

1176