



3+



5



0,6m



1 = 1,59m
2 = 1,19m
3 = 1m



Discapacidad motriz
Discapacidad sensorial
Discapacidad mental

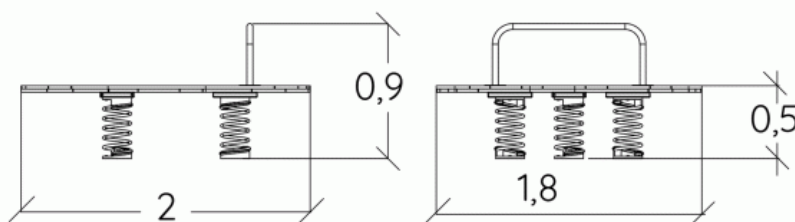

Funciones Lúdicas : 4

imaginar



x1

encontrarse



x1

columpiarse



x1

equilibrio



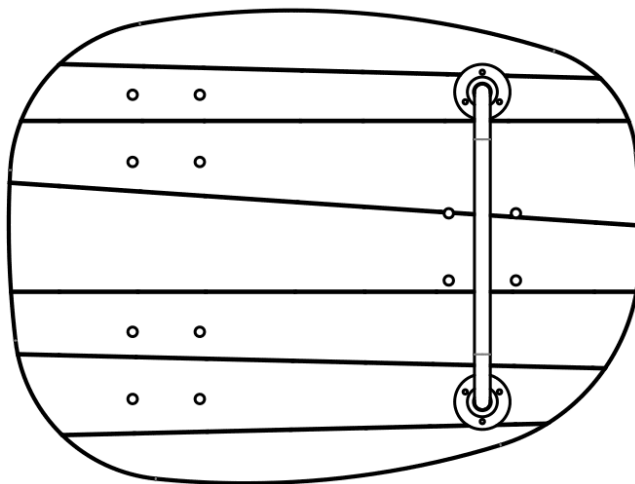

x1

Elementos constituyentes





Instalación del equipamiento

Zona de impacto: Superficie de suelo mínima requerida

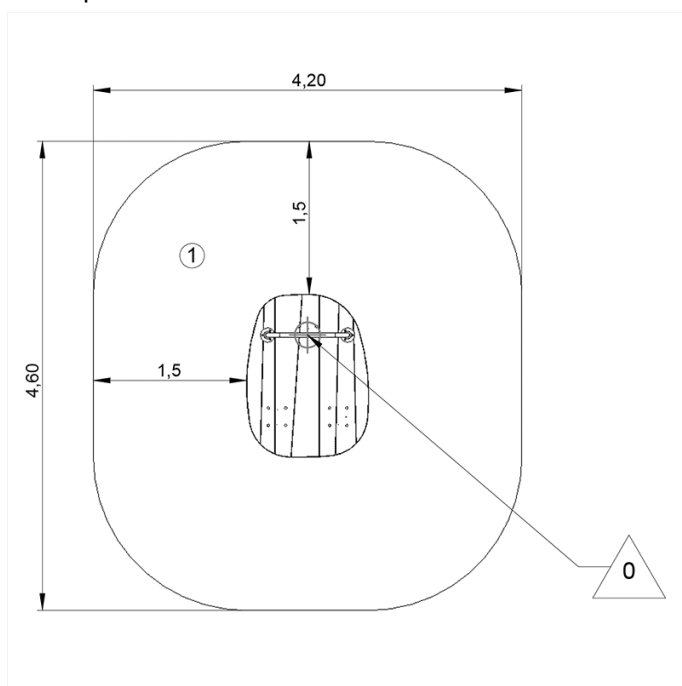
-  Zona de impacto
-  Espacio libre



1	 0,60m	 17,5m ²
---	---	--



2



03h00



0.02m³



17.5m²



122kg



56kg

